

Sack Holder SO-3104

1 Assembling Diagram

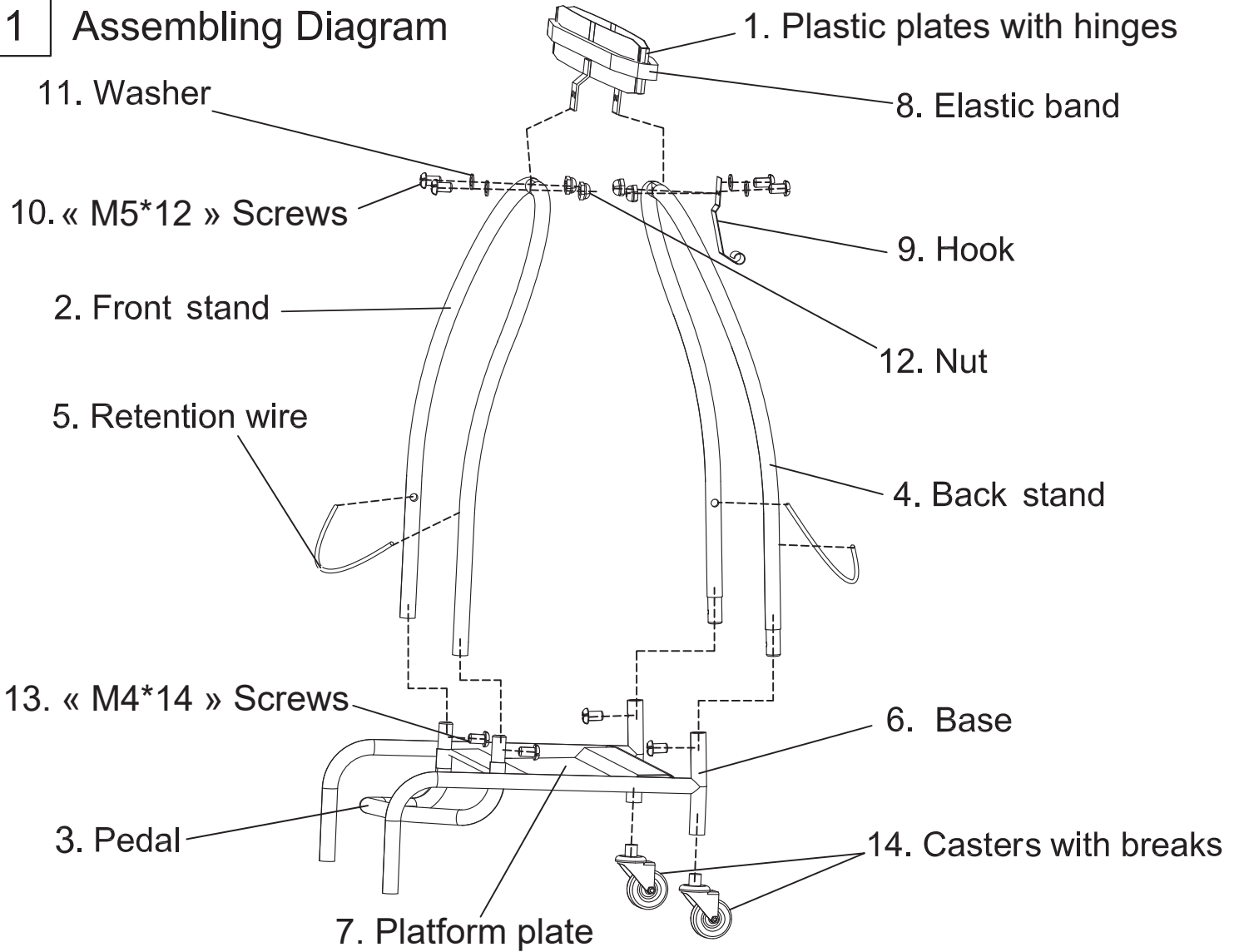

2 List of parts

No	Item	Qty
1	Plastic plates with hinges	1
2	Front stand	1
3	Pedal	1
4	Back stand	1
5	Retention wire	2
6	Base	1
7	Platform plate	1
8	Elastic band	1
9	Hook	1
10	« M5*12 » Screws	4
11	Washer	4
12	Nut	4
13	« M4*14 » Screws	4
14	Casters with breaks	2